

Front Clip / Weatherstrip

1956-62 Door Lock Cylinder Retainer

• Reproduction

26773

8.99 ea.



A9101

49269



A3358



A9100



A3383

1953-62 Outer Door Handles & Hardware

A3358	1956-62 Door Hinge Bushings	1.99 ea.
A9101	1956-62 Handle Button w/Seal	39.99 pr.
A3329	1956-62 Handle Gasket Set (4 pc.)	3.99 set
A3383	1953-62 Courtesy Light Switch Gaskets	3.99 pr.
A9100	1956-62 Handle Kit (10 pc.) [Kit includes left & right handle, screws, gaskets & buttons]	59.99 kit
53303	1956-62 Door Handles *	93.99 pr.
22511	1956-62 Door Handle Reinforcements	19.99 pr.
54169	1956-60 Door Lock Strikers	89.99 pr.
49269	1961-62 Door Lock Strikers	99.99 pr.
54167	1956-62 Door Lock Striker Shims	21.99 pr.
54166	1956-62 Door Lock Striker Screw Set	10.99 set
54168	1956-62 Door Lock Striker Plate Set	21.99 set
54165	1956-62 Door Lock Striker Bumpers	7.99 pr.

* Highest Quality Reproductions Available

1956-62 Outer Door Handle Release Mechanism

• Reproduction
Of Original

48010 27.99 pr.



A8575

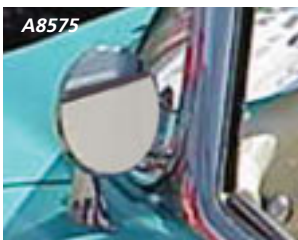

A8575

1953-62 Outer Door Mirrors & Hardware

• Reproduction Of Original

A2400K	Bracket Kit (5 pc.) (For Mounting Mirrors)	11.99 kit
22600	Base Gasket (Paper)	1.99 ea.
A8575	Guide Y-50 Mirror	99.99 ea.
A2400	Mirror (Functional Replacement)	79.99 ea.
A2406C	Screw (Mirror To Bracket)	2.99 ea.



A2400K

A2400

1956-62 Door Lock Screws

• 8 Piece Set

A5519

12.99 set



1956-62 Door Window Felt & Post Channels

• Reproductions Of Original

22563	(Large Stainless Steel Bead)	89.99 set
26919	Door Post Vertical Channels	89.99 pr.

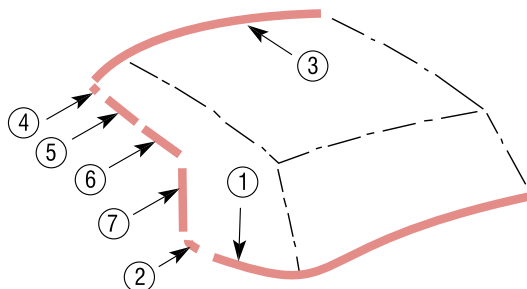

1956-62 Convertible Top & Hardtop Individual Weatherstrips

A3377	1959-60 Convertible Top Rear Bow (1)	21.99 ea.
A3379	1961-62 Convertible Top Rear Bow (1)	14.99 ea.
A3369L	1956-60 Conv. Top Lower Filler, Left (2)	24.99 ea.
A3369R	1956-60 Conv. Top Lower Filler, Right (2)	24.99 ea.
A3368L	1961-62 Conv. Top Lower Filler, Left (2)	25.99 ea.
A3368R	1961-62 Conv. Top Lower Filler, Right (2)	25.99 ea.
A3373	1956-62 Conv. Top Front Header Bow (3)	21.99 ea.
A3376	1956-62 Conv. Top Front Bow Wedges (4)	14.99 pr.
A3374L	1956-62 Conv. Top Side Window Front, Left (5)	16.99 ea.
A3374R	1956-62 Conv. Top Side Window Front, Right (5)	16.99 ea.
A2950L	1956-62 Conv. Top Side Window Center, Left (6)	15.99 ea.
A2950R	1956-62 Conv. Top Side Window Center, Right (6)	15.99 ea.
A3375L	1956-62 Conv. Top Side Window Rear, Left (7)	12.99 ea.
A3375R	1956-62 Conv. Top Side Window Rear, Right (7)	12.99 ea.
A2952	1956-62 Hardtop Front Header (3)	18.99 ea.
20414	1956-60 Hardtop Rear Window & Lower (1)	209.99 ea.
49711	1961-62 Hardtop Rear Window And Lower (1)	249.99 ea.
32756	1956-62 Hardtop Side Horizontal, Left	79.99 ea.
32758	1956-62 Hardtop Side Horizontal, Right	79.99 ea.
A3372	1956-62 Hardtop Vertical Side Rails	59.99 pr.

Weatherstrip Installation Kit

Tools assist in removal of clips, old glue and adhesive and installation of new weatherstrip.

88-0116-1 24.99 kit



SAVE \$10

88-0116-1 Weatherstrip Installation Kit Just \$14.99 when purchased with any complete weatherstrip kit.

Buy A 1958-62 Weatherstrip Kit And Save

Plus save 10%* on additional weatherstrip when purchased along with any of our weatherstrip kits. *Discount cannot be combined with other offers.



33624

1956-62 Body 8-Piece Weatherstrip Kits

• 8-Piece Kits Include:

- | | |
|------------|------------------|
| Hood | Door Auxiliaries |
| Cowl Vent | Deck Lid |
| Door Mains | Truck Lid |

29287	1956-57	122.99 kit
29288	1958	122.99 kit
29289	1959E	129.99 kit
29290	1959L-60	133.99 kit
43743	1961-62 (without Molded Ends on Deck Lid)	151.99 kit
33624	1961-62 (with Molded Ends on Deck Lid)	239.99 kit

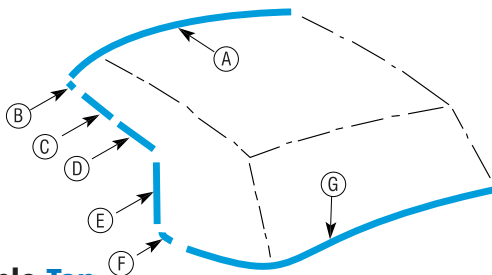

1956-62 Convertible Top Weatherstrip Kits

• 12-Piece Kits Include:

- A. Header
- B. Header Wedges
- C. Front Side Rails
- D. Center Side Rails
- E. Rear Side Rails
- F. Rear Bow Fillers
- G. Rear Bow*

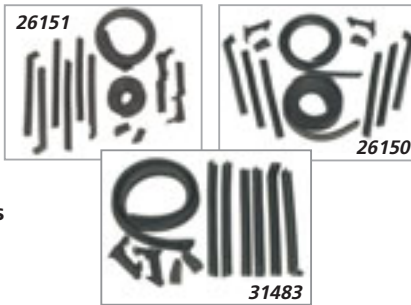

31483	1956-58* (11-piece)	109.99 kit
26150	1959-60	122.99 kit
26151	1961-62	122.99 kit

* 1956-58 Corvettes did not have a rear bow weatherstrip

1958-62 Door Auxiliary Weatherstrip Retainers

• Metal To Door Retainers



A5520 5.99 set

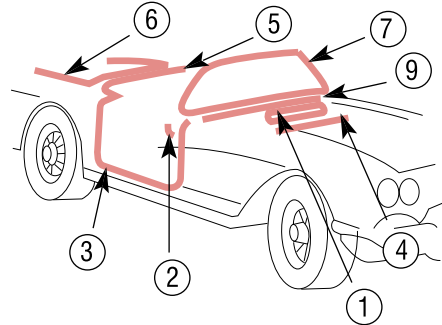
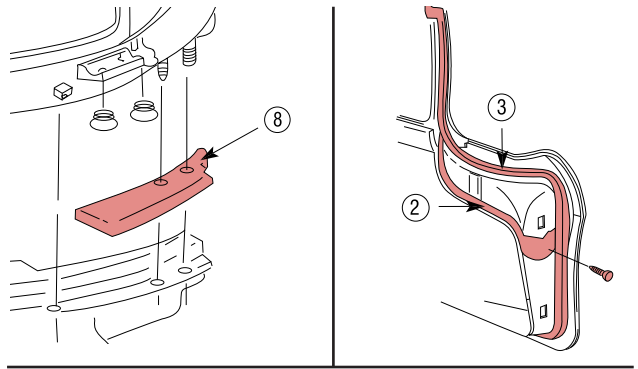

1953-62 Body Individual Weatherstrips

• Reproductions Of Original

25813	1953-62 Cowl Vent Door Gasket (1 pc design) (1)	12.99 ea.
A3370	1956-59E Door Auxiliary† (2)	36.99 pr.
A3371	1959L-62 Auxiliary Door †† (2)	41.99 pr.
A2948L	1956-58 Door Main, Left * (3)	33.99 ea.
A2948R	1956-58 Door Main, Right * (3)	33.99 ea.
A3384	1959-60 Door Main (w/o door post clips) (3)	84.99 pr.
A3385	1961-62 Door Main (w/o door post clips) (3)	104.99 pr.
A2957	1958-62 Hood Rear Edge (4)	8.99 ea.
A2939A53	1953-58 Compartment Lid (Tubular) (5)	12.99 ea.
A2939A59	1959-62 Compartment Lid (5)	12.99 ea.
32757	1961-62 Compt Lid W/Molded Ends (5)	59.99 ea.
A2939-53	1953-58 Trunk Lid (6)	17.99 ea.
A2939-59	1959-62 Trunk Lid (Tubular) (6)	17.99 ea.
32759	1959-62 Trunk Lid (w/Correct Ribs) (6)	29.99 ea.
A2966	1956-62 Windshield Channel (7)	33.99 ea.
A3381	1956-62 Windshield End Frame Seals (8)	3.99 pr.
A2943	1956-62 Windshield Frame to Body (9)	12.99 ea.

* Functional replacement † 59 till S/N 6300 †† 59 after S/N 6300



1956-62 Convertible Top Front Weatherstrip Retainers

28902	1956-58	27.99 ea.	40377	1959-62	27.99 ea.
-------	---------	-----------	-------	---------	-----------

1956-62 Convertible Top Weatherstrip Retainer Kit

• Reproductions Of Original

A3378 6 pc. 23.99 kit



Weatherstrip

1956-62 Body Seal Kits

- Reproduction Of Originals

Includes all the common seals that need replacing when repainting your car. Seals are die-cut from correct material.

25945	1956-57 (24 pc.)	37.99 kit
25946	1958-60 (33 pc.)	39.99 kit
25947	1961-62 (33 pc.)	37.99 kit



1961-62 Trunk Drain Tubes

- Reproductions Of Original
- Allows Water To Drain From Trunk Lid Gutters
- Prevents Water From Entering Trunk

51068	Drain Tubes	9.99 pr.
51069	Grommet	7.99 pr.



1956-62 Door Post Weatherstrip Screws

- Reproductions Of Original

A5527	8 pc.	4.99 set
-------	-------	----------

1959-62 Door Post Weatherstrip Clip Sets

37995	1959-60 (22 pc.)	40.99 set
37994	1961-62 (18 pc.)	35.99 set
37993	1962L (22 pc.)	41.99 set

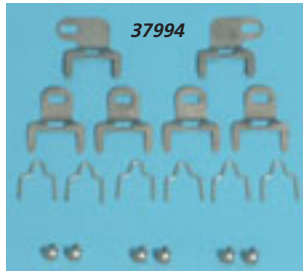

Wurth Rubber Care Gel Stick

- Restores Rubber Parts
- Revitalizes Bumper & Body Side Moldings
- Easy To Use Gel Stick Applicator

88-0193-1	75 ml	17.99 ea.
-----------	-------	-----------

Cannot Ship By Air.



Weatherstrip Saver

• Optimum Results
Krytox® fluorinated grease by DuPont is a weatherstrip saver. It preserves and lubricates to prolong the life of expensive weatherstrip. 2-ounce tube.

A2524	49.99 ea.
-------	-----------

Weatherstrip Lubricant

A budget alternative to Krytox, this product was designed for brake system use but also works well as a weatherstrip lubricant, extending its life and protecting against cracking and discoloration. 5.3-ounce tube.

88-0197-1

16.99 ea.



3M Super Weatherstrip Adhesive

- 5 oz. Tubes

88-0272-1 Yellow 10.99 ea.

88-0273-1 Black 11.99 ea.



1958-62 Tack Strip Kits

- Made Of Fiberboard As Original (Inexpensive Rubber Strips Won't Hold Tacks.)

A8496 1958-60

52.99 kit

A8497 1961-62

44.99 kit

~~Hard Rubber Tack Strips~~



1956-62 Convertible Top Bows

- Reproductions Of Original

A8480	1956-62 Front Header	599.99 ea.
A8486	1956-60 Rear	339.99 ea.
A8487	1961-62 Rear	379.99 ea.

1956-62 Convertible Top Bows

- Reproductions Of Original

40386	1956-62 Bow Position #1	209.99 ea.
40387	1956-62 Bow Position #2	209.99 ea.
40388	1956-62 Bow Position #3	209.99 ea.
A8492	1956-62 Tack Bow (Above window)	309.99 ea.



1956-62 OEM Convertible Top Bow Pad Kits

- Reproductions Of Original

A1562	1961-62	49.99 kit
54814	1956-58 Pad	49.99 kit
54815	1959 Pad	49.99 kit
54816	1960 Pad	49.99 kit

